

VITA ATMOMAT®

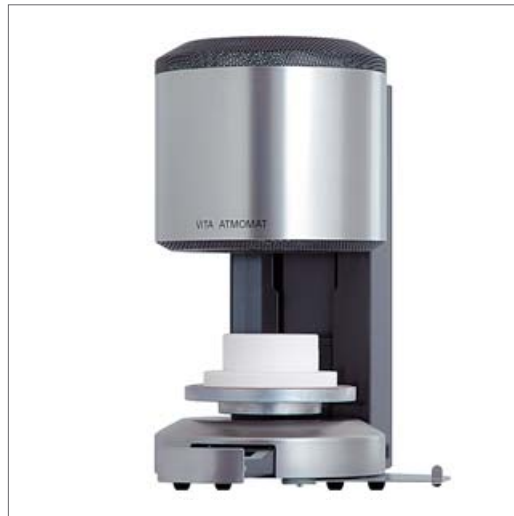

Operating manual

Date of issue: 03-08

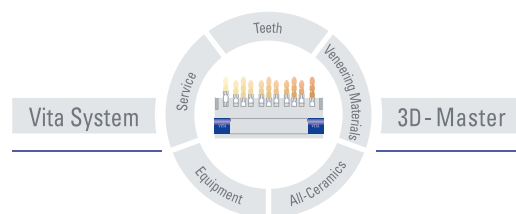

VITA

TABLE OF CONTENTS

1	TECHNICAL INFORMATION	2
1.1	GENERAL FUNCTIONS	2
1.2	TECHNICAL DATA	2
1.3	ELECTRICAL DATA	2
1.4	SCOPE OF DELIVERY	2
1.5	CE-MARK	2
2	INSTALLATION AND STARTING-UP	3
2.1	INSTALLATION	3
2.2	CONNECTING THE FURNACE TO THE MAINS SUPPLY	3
2.3	FURNACE OUT OF OPERATION	3
3	SAFETY ADVICE	4
3.1	INFORMATION OF LABELS	4
3.2	CLEANING OF THE FURNACE	4
3.3	FUSES	5
3.4	COOLING FAN	5
4	PROTECTION AGAINST POWER FAILURE	5
4.1	MAINS POWER FAILURE	5
5	STANDBY - MODE	6
5.1	START	6
5.2	STOP	6
6	FIRING PROGRAMS	6
6.1	GENERAL INFORMATION ON FIRING PROGRAMS	6
6.2	FUNCTION OF KEYS IN THE ON-, SET- AND RUN-MODE	7
6.3	SELECTING A PROGRAM, CHANGING PROGRAM VALUES	8
7	UTILITIES	10
7.1	FUNCTION OF KEYS IN THE UTILITIES MODE:	10
7.2	SERVICE NO. 1 STANDBY	10
7.3	SERVICE NO. 2 LIFT SPEED	10
7.4	SERVICE NO. 3 LIFT POSITIONS PRE-DRYING	11
7.5	SERVICE NO. 4 LIFT POSITION COOLING	12
7.6	SERVICE NO. 5 INTERVALS FOR LIFT POSITION PRE-DRYING	12
7.7	SERVICE NO. 6 SIGNAL TIME	13
7.8	SERVICE NO. 7 FUNCTION STOP-KEY	13
7.9	SERVICE NO. 8 SHOW TOTAL OPERATING HOURS	13
7.10	SERVICE NO. 9 SHOW TOTAL OPERATING HOURS MUFFLE	14
7.11	SERVICE NO. 10 CALL UP FURNACE NO.	14
7.12	SERVICE NO. 11 CALL SOFTWARE NO.	14
7.13	SERVICE NO. 12 ENTER FURNACE PARAMETERS	15
7.14	SERVICE NO. 13 READ IN FIRING TABLE	16
7.15	SERVICE NO. 14 SERVICE-HOTLINE	17
7.16	SERVICE NO. 15 TEMPERATURE ADJUSTMENT WITH SILVER SAMPLE	17
7.16.1	Silver sample - Set VITA - Order No. B 230	18
7.17	SERVICE NO. 16 AUTOMATIC TEMPERATURE ADJUSTMENT	19
7.18	SERVICE NO. 17 CODE DIGIT FOR PC CONNECTION	19
7.19	SERVICE NO. 18 ACTIVATE DATA RECORDING (EXTRA)	20
8	ERROR MESSAGES	21
8.1	ERROR MESSAGES ERROR 01 - ERROR 29	21

1 TECHNICAL INFORMATION

1.1 General functions

- 5 freely selectable firing programs
- Illuminated graphic display
- Easy to read display to monitor program sequence status
- Freely selectable slow cooling phase for each program
- Highest temperature accuracy
- Temperature adjustment program
- In case of power cut < 20 sec no abortion of program
- In case of power cut > 20 sec all parameters are stored
- Choice of 3 lift positions in pre-drying phase

1.2 Technical data

Width: 220 mm
 Depth: 320 mm
 Height: 420 mm
 Casing: steel / stainless steel
 Weight: 10.5 kg
 Firing chamber - capacity: Diameter : 90 mm
 Height: 55 mm
 Firing chamber temperature: max. 1180 °C

1.3 Electrical data

Power supply: 230 Volts A.C. 50 Hz
 Power consumption: max. 1500 Watts
 Classification: Safety class 1

1.4 Scope of delivery

Furnace in special shipping carton with:

- 1 Firing tray
- 1 Mains power lead
- 1 Pair of furnace tweezers
- 1 Set of firing trays A + B
- 1 Set of firing trays G
- 1 Operating manual

1.5 CE-mark



The use of the CE-mark entails the legally binding statement that the unit complies with the basic requirements of guideline 73 / 23 / EEC (Low Voltage Guideline) as well as guideline 89 336 / EEC (EMV - guideline).

2 Installation and Starting-up

2.1 Installation

- When positioning the furnace, the minimum distance of the furnace and any wall is at least 25 cm
- Make sure that the unit is placed on a heat-resistant surface. Heat radiation and heating-up of the furnace lies within a harmless range. However, it cannot be excluded that sensitive furniture surfaces and veneerings may exhibit slight discoloration due to continuous exposure to heat.
- The unit must not be exposed to direct sunlight.
- Do not place any combustible objects near the furnace.

2.2 Connecting the furnace to the mains supply

Notice: Prior to starting-up, observe safety advice item 3

- Connect furnace to mains supply with the enclosed mains power lead. (fig. 1) Do not use multiway socket outlet with extension, overload may result in a fire.
- Switch on the furnace with the main switch (Abb. 1), lift will descend into lower position.
- Place the firing tray onto the lift support plate. (Abb. 2)
- Push operating panel to open it. (Abb. 2 + 3)
- Activate with Standby Mode key (for further information see Standby Mode)

Figure 1

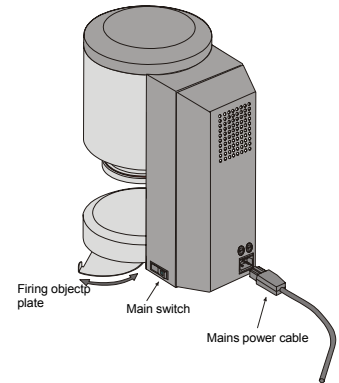

Figure 2

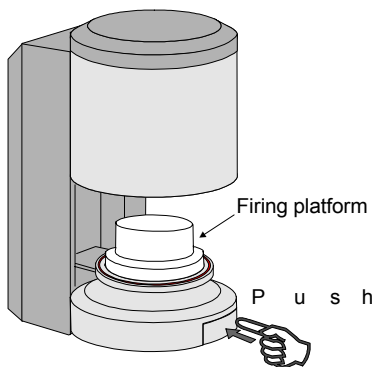
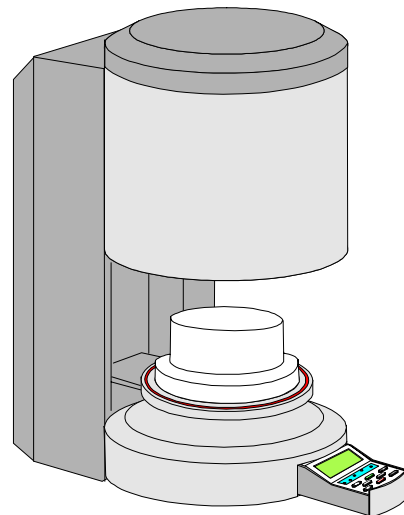



Figure 3



2.3 Furnace out of operation

If the furnace is not used, the lift should be moved with  into the firing chamber and the unit should be switched off with the main switch (see fig.1). Closing the firing chamber will protect the insulation and avoid the absorption of moisture.

3 Safety advice

For your personal safety we would like to ask you to read the following safety-relevant information completely before starting-up the furnace.

3.1 Information of labels

This is a warning symbol about dangerous electrical current. Disconnect furnace from the mains power supply before opening it for maintenance or repair work.



Caution if rear panel is removed:

If the unit is switched off, there may be a residual voltage of up to 400 volts at some parts in the area of the power supply unit.

The manufacturer disclaims any liability for accidents of the user if the furnace is not closed.

Caution: Do not place any objects near the lift tray, when the unit is switched on, the lift will descend into the lower position. (fig 4)



Use lateral plate to place firing objects on.

Furnaces must not be operated without firing tray. (Abb. 2)

Figure 2

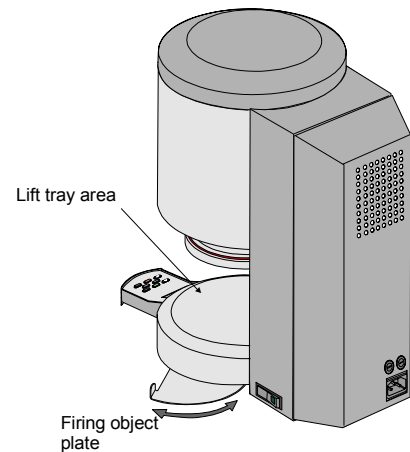

During continuous operation (max. end temperature, max. firing time) some parts of the firing chamber may reach high temperatures (above 70 °C).

If the unit is connected to the mains supply, do not reach into the open firing chamber to avoid contact with live and hot components.

3.2 Cleaning of the furnace

Unplug the unit each time before it is cleaned !!

It is not necessary to clean the interior of the firing chamber; cleaning of the casing with a wet cloth within regular intervals will ensure operational reliability (especially of the lift drive).

Do not use hot objects for the keys of the operating panel e.g. pair of tweezers. Operating panel should only be cleaned with a dry cloth or a brush.



Basically, no cleaning agents and no flammable liquids must be used for any type of cleaning work.

3.3 Fuses

In the rear panel there are two fuses for the furnace. The labels provide information on the fuses used in the unit. Fuses with different values must not be used.

8 Ampere

1 Ampere

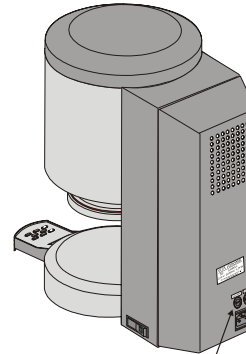

Fuses

3.4 Cooling fan

The furnace has been equipped with a cooling fan which will be switched on and provide half of its power after starting a firing program at a temperature of 605 °C to 800 °C in the firing chamber and then offer full power up to the end of the program and the cooling process.

The cooling fan avoids excessive heating of the furnace and contributes to ensure the general operational reliability of the furnace.

In case of failure of the cooling fan an error message is shown on the display (see error messages).

Do not block the upper cover of the firing chamber or the openings of the rear panel.

4 Protection against power failure

4.1 Mains power failure

The Atmomat furnace is protected against power failure.

Program abortion and thus incorrect firing is avoided in case of a short failure of the mains voltage supply.

This backup device is activated immediately in the event of a mains power failure during an active firing program.

In case of a failure of less than 15 sec, the program continues and is not aborted.

Display shows Error 09 (see error messages).

Pressing the Stop key deletes the Error message and the date of the program sequence will be shown on the display again.

ERROR: 09
Core Recover
Continue: Stop

In case of a failure of more than 15 sec the program is aborted and the display shows Error 08 (see error messages).

Pressing the Stop key deletes the Error message.

ERROR: 08
Power Fail
Continue: Stop

5 Standby - Mode

LCD display shows e.g.

5.1 Start

Switch on furnace with the main switch - *lift*



Start - *lift*



5.2 Stop



Stop - *lift*

Changing the Standby temperature see utilities No. 1

6 Firing programs

6.1 General information on firing programs

5 freely selectable firing programs are available.

Generally the firing program will only start when the pre-drying temperature has been reached.

The program steps are indicated by LEDs.

The programs include the following adjustable parameters:

- Pre-drying temperature 200°C - 600°C
- Predrying time 0 - 10,00 min/sec.
- Temperature rising rate 75 °C/min (cannot be changed)
- End temperature 200 °C - 1180 °C
- Hold-time for end temperature 0 - 10,00 min/sec.
- Cooling temperature 200 °C - 900 °C (selection --- no cooling)

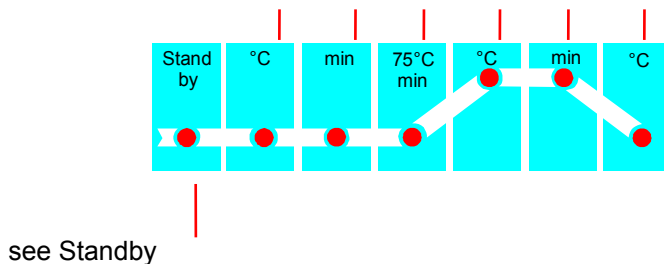

Display shows e.g.

If firing program is *selected*, display shows:

Prog Set 1 = Input-mode active
 Firing chamber temperature
 Program No.

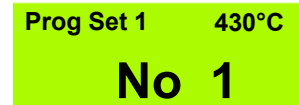

LEDs in the Set-mode:

Light up = program step programmed
 Off = program step not programmed
 Flash = Change of value/entry possible

During *running* firing program display shows :

Prog. No. with display Run (Program run active)
 Time or temperature of the active program step
 Current temperature in the firing chamber



LEDs in the Run-mode:

Light up = program step programmed
 Flash = program step active
 Off = program step completed/off.

6.2 Function of Keys in the On-, Set- and Run-mode

The Mode : **On** = units switched on, lift in lower position, no active program
Set = program selected, check/change program values
Run = program started,
 (Set and Run are shown on the display.)

Start *On-Mode*: start Standby
Set-Mode: start program
Run-Mode: no function

Stop *On-Mode*: no function
Set-Mode: press 1x to cancel changes,
 press 2x to end Set-mode.

Run-Mode: program abortion (see also utilies No. 7)

Progr. *On-Mode*: activates Set-Mode, program that was selected last is called.
Set-Mode: end Set-Mode.
Run-Mode: call Set-Mode
 (is automatically ended, if no request/check is performed with the up/down key within 10 sec).



On-Mode: manually moving lift up/down
Set-Mode: selection of program steps and simultaneous storage of the value changed last.



Run-Mode: manually moving lift up/down (not active, if lift is in upper position)
 Requesting the program values (if Set-Mode has been selected with Progr. key).



On-Mode: no function



Set-Mode: change of program No. and program values, plus/minus
Run-Mode: no function.



On-Mode: call utilities (see utilities)
Set-Mode: no function.
Run-Mode: no function.

6.3 Selecting a program, changing program values

Precondition: Lift tray in lower position, no active program.

If data entry is interrupted for more than 10 sec, program entry (Set Mode) is ended and the display shows the current temperature in the firing chamber.



- Display shows program that was activated last, e.g. No. 1

Values that were programmed actively in the program (time or temperature set) are indicated by the corresponding flashing LED.
 (e.g. no temperature set during the cooling phase, LED does not flash).



Program starts

or

Select program No.



Program starts

or

Check/change pre-drying temperature

display shows values for pre-drying temperature
● °C () flashes

change the value

value O.K. program



or

Check/change pre-drying temperature

 display shows value for pre-drying temperature
● min () flashes

change the value  

value O.K. program 

or

Check/change firing temperature

 display shows value for end temperature
● °C () flashes

change the value  

value O.K., program 

or

Check/change time for firing temperature

 display shows value for holding time end temperature
● °C () flashes

change the value   *or*

value O.K., program 

or

Check/change cooling temperature

 display shows value for cooling temperature
● °C () flashes

  change the value

value O.K., program 

7 Utilities

7.1 Function of keys in the utilities mode:

Precondition: Furnace On, lift tray in lower position, no active program.

Service Activate utilities program, start with No. 1
Store changes and end utilities program.

+ **-** for changes of values plus/minus

▽ **△** store changes and activate next utility program.

Stop 1x = set back changes of values

2x = end utility program

7.2 Service No. 1 Standby

press **Service**
display shows currently selected value (e.g. 600°C)

+ **-** select value (Selectable range 200°C - 600 °C)

Service store and end

or

△ or **▽** store and select next utility program.

Standby No. 1
600 °C

7.3 Service No. 2 Lift speed

Service then **△** press until Service No. 2 is displayed

Value for moving into firing chamber underlined

+ **-** select value (Selectable range approx. 6 - 16sec. closing time)

Service store and end



or

Service No. 2
10sec 14sec
↑ SPEED ↑

 select value for descending time



Descending value underlined

Service No. 2		
10 <u>sec</u>		<u>14sec</u>
↑	SPEED	↑

  select value (selectable range approx. 6 - 16 sec. opening time)



 store and end

or

 or  store and select next utility program.



Notice: To determine the correct speed, the lift will move into the upper or lower position 3 sec after selecting/changing the value.



7.4 Service No. 3 Lift positions pre-drying

 then  confirm until Service No. 3 is displayed.

3 sec after selecting, the lift will move into the position



value of position 1 underlined.



  select value of position 1. (Selectable range 0 - 30 %)

Service No. 3		
<u>5%</u>	15%	<u>45%</u>
1 	2 	3 

 select position 2.



value of position 2 underlined.



  select value of position 2 (selectable range 0-50%, not lower than pos. 1)

Service No. 3		
5%	<u>15%</u>	<u>45%</u>
1 	2 	3 

 select position 3



value of position 3 underlined.

  select value of position 3. (Selectable range 0-80%, not lower than pos. 2)

Service No. 3		
5%	15%	<u>45%</u>
1 	2 	3 



 store and end

or

 or  store and select next utility program.



7.5 Service No. 4 Lift position Cooling

Service then  confirm.

  select value (selectable range 0 – 80 %)

Service store and end

or



 or  store and select next utility program.

3 sec after selecting or changing, the lift will move into the position.



Service No. 4
40%

7.6 Service No. 5 Intervals for lift position pre-drying

Service then  press until Service No. 5 is displayed
value of position 1 is underlined.



  select value of position 1
(Selectable range 0 - 60 sec.)



 select position 2
value of position 2 underlined



  select value of position 2, (selectable range 0 - 60 sec.)

Service store and end

or



 or  store and select next utility program.



Service No. 5
20 sec 50 sec
1  2 

Service No. 5
20 sec 50 sec
1  2 

7.7 Service No. 6 Signal time



Service then  press until
Service No. 6 is displayed.

Service No. 6
 **5 sec**

  select value, (Selectable range 0 - 20 sec.)

Service store and end



or

 or  store and select next utility program

7.8 Service No. 7 Function STOP-key



Service then  press until
Service No. 7 is displayed.

Service No. 7
STOP 1x

  select setting.
1 = program aborted press Stop 1x
2 = program aborted press Stop 2x

Service store and end

or

 or  store and select next utility program.

7.9 Service No. 8 Show total operating hours.

Service then  press until Service No. 8 is displayed.

Service No. 8
00150 h

Service end



 or  select next utility program.

7.10 Service No. 9 Show total operating hours muffle.

Service then  press until Service No. 9 is displayed.

Service end

or

 or  select next utility program.

Service No. 9
00110 h

7.11 Service No. 10 Call up furnace No.

Service then  press until Service No. 10 is displayed.

Service end

or

 or  select next utility program.

Service No. 10
01200

7.12 Service No. 11 Call software No.

Service then  press until Service No. 11 is displayed

Core = software No. operating panel
CTRL = Software No. main board

Service end

or

 or  select next utility program.

Service No. 11
CORE : V 31
CTRL : V 31

7.13 Service No. 12 Enter furnace parameters

Notice: When this program is run, individual values that have been entered will be overwritten with the values recommended by the furnace facturer.

Pre-stored basic settings for:

Display shows e.g.

Service No. 1 Standby temperature 500°C

Service No. 2 Lift speed, = 10 = 14

Service No. 3 Lift positions for pre-drying pos.1 = 0%
pos.2 = 25%
pos.3 = 50%
Service No. 4 Lift position for cooling pos.4 = 50%

Service No. 5 Intervals for lift positions pos.1 = 50 sec.
pos.2 = 50sec.

Service No. 6 Time for buzzer 5 sec

Service No. 6 Abortion of firing program 1 = 1x Stop

Service No. 15 Temperature adjustment with silver sample Temp - Offset = 0

Service No. 16 Automatic temperature adjustment On



Service No. 17 Code digit for PC connection 1

Service No. 18 Store process data Off



Service No. 12
Service Defaults
00141h auto

00016h = was performed last at
00016 operating hours.
man = performed manually (with
progr. No. 9)
or
display auto = automatic (only
with new board)

Read basic furnace setting in the memory:

 then  press until Service No. 12 is displayed.

read in memory with key

 or  keep pressed for 5 sec ,
(countdown on the display), only then
basic furnace settings are read in the memory.

 end

or



 or  select next utility program.

7.14 Service No. 13 Read in firing table

Service then  press until Service No. 13 is displayed.

read in memory with key

**Service No. 13
Program Defaults
00141h auto**

 or  Keep key pressed for 5 sec ,
(countdown in the displs), only then
program values are read in the memory.

**Service No. 13
Program Defaults
<<< 5 sec
00141h auto**

- = performed last after 141 operating hours
- = automatically when starting-up the furnace
- = performed again after 500 operating hours
- = carried out manually

**Service No. 13
Program Defaults
Loaded
00500h man**

Notice : After this program has been run, all program values that had been entered individually will be deleted.
The program values correspond to the firing table recommended by VITA.
(see firing table)

Service end

or

 or  select next utility program

Firing table



Progr. No.	Firing process	Vt -temperature	Vt - time	Firing temperature	Holding time	Cooling temperature
1	Cleaning firing	600 °C	4:00 min	800 °C	1:00 min	---
2	Fixation firing with Shading Paste	600 °C	4:00 min	930°C	1:00 min	---
3	Glaze firing with Shading Paste	600 °C	6:00 min	950 °C	1:00 min	---
4	Fixation firing with Akzent	600 °C	4:00 min	900 °C	1:00 min	---
5	Sealing with Akzent Glaze	600 °C	6:00 min	920 °C	1:00 min	---

7.15 Service No. 14 Service-Hotline

Service then  press until Service No. 14 is displayed.
display shows Tel. * 49 (0) 7761/562222

Service end
or

Service No. 14
* 49 (0)7761 - 562222

 or  select next utility program.

7.16 Service No. 15 Temperature adjustment with silver sample

With this program and the VITA silver sample set (VITA Order No. B 230) the temperature in the firing chamber can be checked and readjusted in the range of plus/minus 20 °C. Upon readjusting it must be ensured, that the instructions to perform (instructions in the silver sample set) the test with the silver sample are strictly adhered to. Noncompliance leads to incorrect measurements and thus to incorrect adjustment.

See also Service No. 16, automatic temperature adjustment.

Service then  press until Service No. 15 is displayed

Service No. 15
Temp Adjust
Temp- Offset: 0

Check program values:

Progr. then check program values with  displays shows pre-drying temperature, pre-drying temperature LED flashes. (see also selecting a program, changing program values, item 6.3)

Prog Set 6 450°C
600 °C



change with keys

 or 

program should include the following values:

- Pre-drying temperature 600°C
- Pre-drying time 1:00 min
- Temperature rising rate 75 °C/min (automatically)
- End temperature 955 °C
- Holding time for end temperature 4:00 min

Changed values must be stored with the keys

 or 

or

Stop end check/input of program values

or

Service No. 15
Temp Adjust
Temp-Offset: 0

Start program:

Place silver sample on lift tray

Prog Run 6 450°C
600 °C

Start press, programm starts.

* *acoustic signal at the end of the program*

Stop signal off

**melting point of silver sample is O.K.
(silver should have melted slightly)**

Service program completed

o r

melting point of silver sample not O.K.

+ **-** select **manual** temperature adjustment,
e.g. 10°C
(range plus/minus 20°C)

**Service No. 15
Temp Adjust
Temp-Offset: 10°C**

then **Start**

Program starts - see, * *acoustic signal at the end of the program.*

When the melting point of the silver sample is reached, the temperature-offset value will be

stored when the **Service** key is pressed.

Temperature control and thus the temperature in the firing chamber is adjusted.

7.16.1 Silver sample - Set VITA - Order No. B 230

VITA silver sample set for temperature control contains:

- Description
- VITA silver sample set for temperature control
- 6 ceramic trays
- 3 silver rods with a length of 70 mm and a diameter of 1.5 mm

7.17 Service No. 16 Automatic temperature adjustment

Automatic temperature adjustment is activated after switching on the unit at intervals of 100 operating hours of the muffle.

During this process the displays shows for approx. 15 sec.

**Auto Elektronik
Temp Adjust**

Preconditions are:

- Automatic temperature adjustment ON (utility program No. 16)
- 100 operating hours of muffle have expired
- Temperature in the firing chamber lower than 50 °C

Automatic temperature adjustment considers/corrects any deviation of the electronic components within the temperature measuring circuit. Accordingly, a constant temperature control of +/- 1°C is ensured even when the furnace is operated over longer periods.

Service then  press until
Service No. 16 is displayed.

**Service No. 16
Auto Electronic
Temp Adjust on**

 key to select ON

 or OFF

Service end or



 or  select next utility program.

7.18 Service No. 17 Code digit for PC connection

If the firing data are recorded with the PC-program (extra) the furnace must receive a code digit.



**Service No. 17
RS232 ID: 1**

Service then  press until Service No. 17 is displayed.

  enter value resp. code digit for furnace.
(Selectable range 0 - 255)

Service end

or

 or  select next utility program

7.19 Service No. 18 Activate data recording (extra)

To save the firing data and to transfer them to the PC program (extra) later, the memory must be activated.

Service then  press until service No 18 is displayed.

  ON or OFF

Service end

or

 or  select next utility program

Service No. 18
Save
Process Data
off

8 Error messages

8.1 Error messages Error 01 - Error 29

In case of a malfunction Error xx is shown on the display.

The message can be reset by pressing the Stop key or by switching the unit on and off.

If the malfunction is not eliminated, the message is repeated, the unit, however, can only be operated after the elimination of the malfunction.

When one of the the error messages listed below is displayed, it is necessary to contact the manufacturer or an authorized service company; see also Service No. 14 Service Hotline.

In many cases it is necessary to open the furnace in order to detect or to verify an error that has occurred.

For this purpose the aspects described under **Safety Advice** must be considered.

display shows

Error 01 firing temperature exceeded by more than 20 °C or transposition of thermocouple connections.

ERROR: 01
Temp-Burn >>
Continue: Stop

Error 02 Firing temperature exceeded by more than 30 °C during rising

ERROR: 02
Temp-Ramp >>
Continue: Stop

Error 03 Break of temperature sensor, cooling fan runs immediately

ERROR: 03
Temp-Sensor
Continue: Stop

Error 04 Malfunction limit switch for lower lift position

ERROR: 04
LiftHomePos
Continue: Stop

Error 05 Error resp. failure of cooling fan

ERROR: 05
Cooling Fan
Continue: Stop

Error 06 Error resp. failure of lift motor

ERROR: 06
LiftMotor
Continue: Stop

Error 07 Error resp. failure of speed measurement

ERROR: 07
LiftPosSig
Continue: Stop

Error 08 Error voltage supply resp. supply unit
(see Protection against Power Failure)

ERROR: 08
Power Fail
Continue: Stop

or

Error 09

ERROR: 09
Core Recover
Continue: Stop

Error 10 Error, muffle defective.

ERROR: 10
Heating
Continue: Stop

Further error messages:

Error messages Error 11 to Error 29 generally refer to malfunctions of the electronic system as well as communication errors between the operating panel and the main board.

When these errors occur, the manufacturer or an authorized service company should be contacted.

With the unique VITA SYSTEM 3D-MASTER®
all natural tooth shades are systematically
determined and completely reproduced.

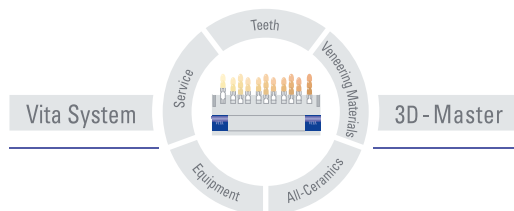

Please note: Our products should be used according to the working instructions. We cannot be held liable for damages resulting from incorrect handling or usage. The user is furthermore obliged to check the product before use with regard to its suitability for the intended area of applications. We cannot accept any liability if the product is used in conjunction with materials and equipment from other manufacturers which are not compatible or not authorized for use with our product. Furthermore, our liability for the correctness of this information is independent of the legal ground and, in as far as legally permissible, is limited to the invoiced value of the goods supplied excluding turnover tax. In particular, as far as legally permissible, we do not assume any liability for profit loss, for indirect damages, for consequential damages or for claims of third parties against the purchaser. Claims for damages based on fault liability (culpa in contrahendo, breach of contract, unlawful acts, etc.) can only be made in the case of intent or gross negligence. Date of issue of these directions for use: 03-08.



VITA

VITA Zahnfabrik H. Rauter GmbH & Co. KG
Postfach 1338 · D-79704 Bad Säckingen/Germany
Tel. +49/(0)7761/562-0 · Fax +49/(0)7761/562-299
Hotline: +49/(0)7761/562-222 · Fax +49/(0)7761/562-446
www.vita-zahnfabrik.com · info@vita-zahnfabrik.com